

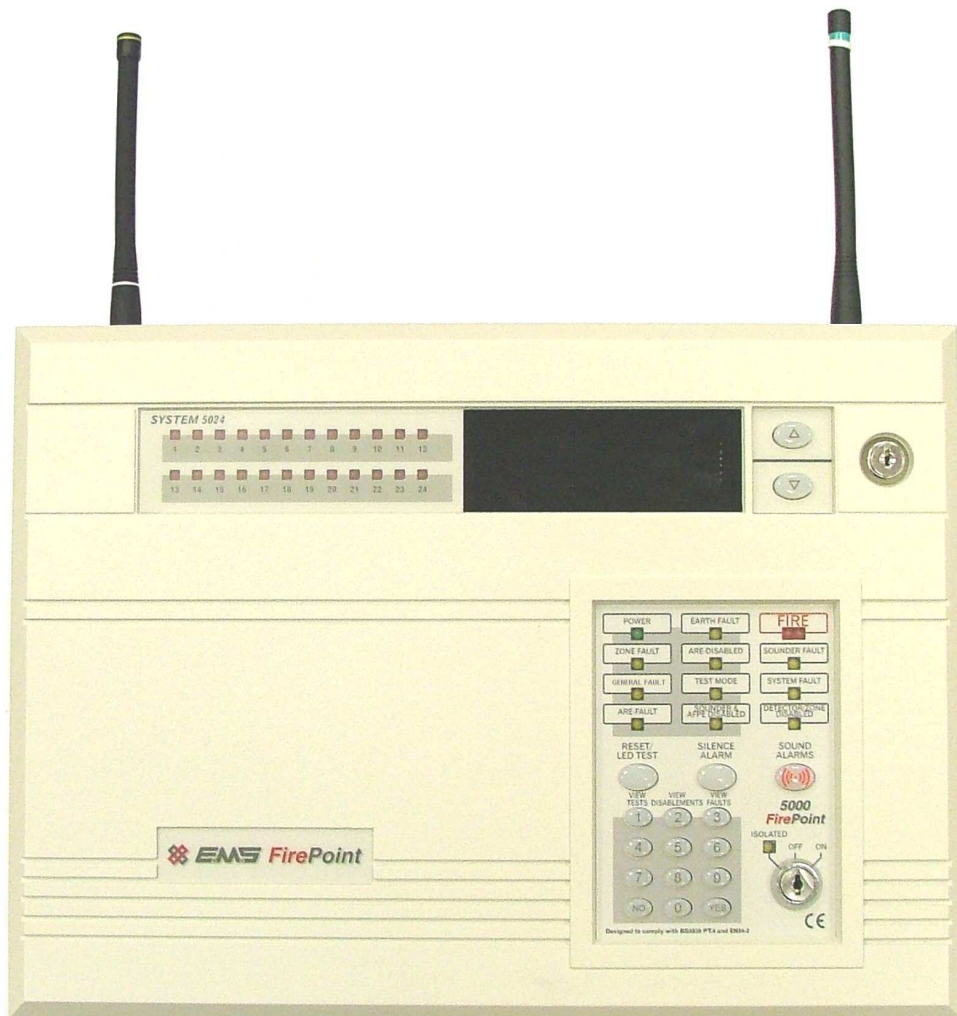

FirePoint

SYSTEM 5000



USER MANUAL

Table of Contents

Section	Page No
1 Introduction: -	3
1.1 Procedure:	3
1.2 Warnings and Cautions:	3
2 User Control Levels:	4
3 User Passwords:	4
4 Controls and Displays: -	5
4.1 Controls Layout:	5
5 Table of the Functions of the panel's LED Indicators: -	6
6 Control Keyswitch:	7
6.1 OFF (Normal) Position Functionality: (Access Level 1)	7
6.2 ON Position Functionality: (Access Level 2)	8
6.3 ISOLATED Position Functionality:	9
7 User Option Functions:	10
8 Alphanumeric Display Indicators: -	12
8.1 Non-Alarm Conditions:	12
8.15 Fire Event:	12
8.2 Fire (Networked Device):	13
8.25 Pre-Alarm:	13
8.3 Tamper:	13
8.35 Fault Event:	14
8.4 Fault : BT: MN:	14
8.45 Fault : BT:	14
8.5 Fault : PR:	15
8.55 Fault : RI:	15
8.6 Fault : OL:	15
9 Step by Step Guidance:	16
9.1 Weekly Test Recommendations	16
9.3 Enabling/Disabling Devices:	18
9.4 Enabling/Disabling Zones:	19
9.5 Enabling/Disabling Brigade Relay:	20
9.6 Printer Options: -	20
9.7 Viewing the Event Log:	21
9.8 Enabling/Disabling Networked Devices:	22
9.9 Selecting Verify Delay Operation:	23
10 Routine Tests: -	24
10.1 Daily:	24
10.2 Weekly:	24
10.3 Quarterly:	24
10.4 Annually:	24
10.5 Periodic Cleaning:	24
11 Logbook: -	25

1 Introduction: -

This manual contains all of the information required for the use and operation of the EMS System 5000. This manual is also written in a format that presumes that the system has been correctly installed and commissioned. When using the system it is important to follow this user manual at all times. Any questions on the system should be put to the Installer/Maintainer.

1.1 Procedure:

In accordance with BS5839 Part 1:2002, written procedures must be established in dealing with alarms for: -

Fire, Fault Warnings and the Disablement of any part of the System.

A responsible person should be appointed who ensures that all users are instructed in the proper use of the system and are familiar with all associated procedures. The nominated person shall also be responsible for liaising with the maintenance company, on all matters relating to the maintenance of the system. One of the associated procedures is to maintain an up to date logbook.

The logbook should include properly recorded events including all real and false alarms. Also any testing or even temporary disablements should be noted. Infact, any events affecting the system should be recorded. It should always be kept in a safe place near the system, only with access by authorised personnel. A sample logbook sheet is displayed in Section 11.

1.2 Warnings and Cautions:

These instructions contain the procedures to follow in order to operate the System 5000 control panel correctly. It is assumed that the user has been suitably trained and is familiar with the relevant regulations.

All equipment is to be operated in accordance with the appropriate standards applicable.

The material and instructions covered in this manual have been carefully checked for accuracy and are presumed to be correct. However the manufacturer assumes no responsibility for inaccuracies and reserves the right to modify and revise this document without notice.

2 User Control Levels:

System 5000 has three different access levels. They are Levels 1, 2 & 3.

At User Level 1, all of the displays are completely functional, however the panel's control buttons and menu access features are inhibited.

At User Level 2, (Standard user access level via control keyswitch); all panel controls are functional and the control panel's menu is accessible. The requirement of the Engineers PIN at the Engineers Config Menu, allows access to Level 3.

At User Level 3, all the panel's controls are functional and the control panel's menu is fully accessible making full system configuration possible. User Level 3 is reached by entering the Engineers PIN from Level 2. (Engineers Config Menu). User Level 3 is intended for use by the System Installer/Maintenance Contractor.

3 User Passwords:

It is possible for the system to be programmed to allow a PIN number rather than the control keyswitch to change from Access Level 1 to Level 2.

The system is not programmed, as standard with this feature as the control keyswitch is normally used, however up to 99 User PINS can be assigned/changed at User Level 3 by the Installer/Maintenance Contractor if required.

4 Controls and Displays: -

4.1 Controls Layout:

The System 5000 control panel provides status information via the Display, Zone Lamps and Status Lamps. The display and control of the panel's functions is achieved through two control panel sections. **Figure 1**, shows the display area which includes Fire Zone Lamps, the Display itself and the “Δ” and “∇” Scroll Buttons.

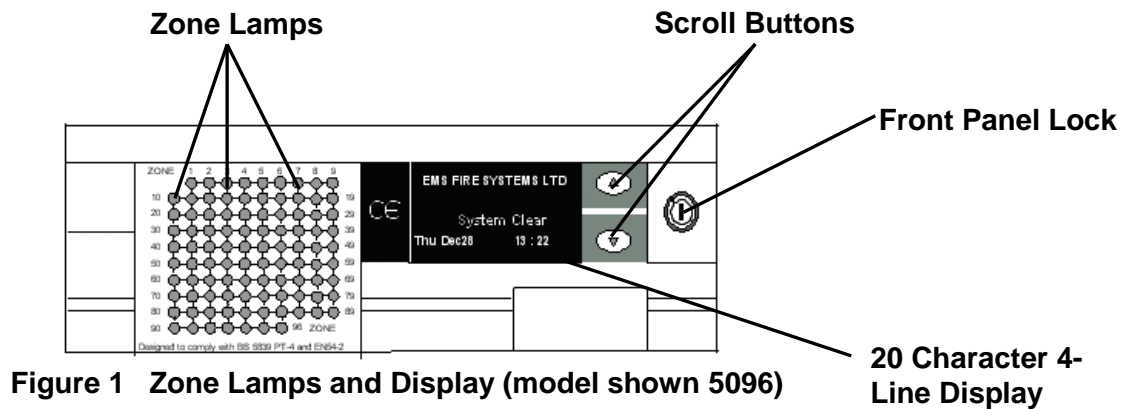

Figure 1 Zone Lamps and Display (model shown 5096)

The System 5000 Panel is controlled by the use of the Control Keyswitch, a Numeric Keypad and 3 Control Buttons. **Fig 2** shows the Panel Controls and Indicator Lamps.

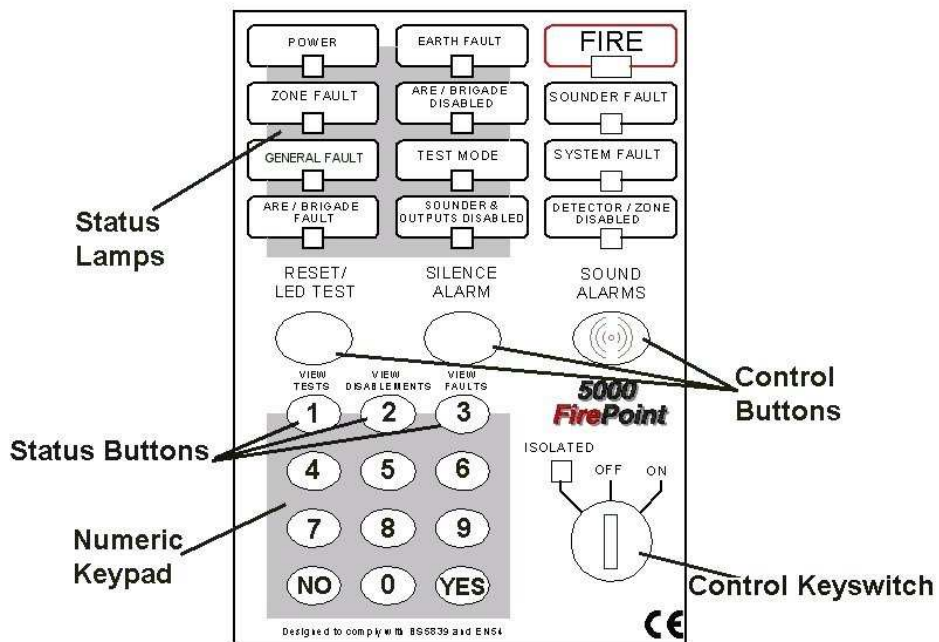

Fig 2

NOTE: The Status Lamps/Buttons & Control Keyswitch/Buttons operation is identical, for all styles of control panel.

5 Table of the Functions of the panel's LED Indicators: -





LED Indicator	Led Colour(s)	Control Panel Function
POWER		Indicates a good AC power supply.
ZONE FAULT		Illuminates, should one of the detection devices, develop a fault condition.
GENERAL FAULT		Illuminates, should a fault condition occur within a Control Panel or device.
ARE / BRIGADE FAULT		Illuminates should a communication fault occur between the Alarm Routing equipment and the Control Panel.
EARTH FAULT		Illuminates should an earth fault condition occur on the system.
ARE / BRIGADE DISABLED		Illuminates when communication with the Alarm Routing Equipment is disabled
TEST MODE		Illuminates whilst a device or detection zone is in "TEST MODE".
SOUNDER & OUTPUTS DISABLED		Illuminates when an individual Sounder/Output device or sounder zone is disabled.
FIRE		Illuminates when any device is in Fire Alarm condition along with the fire zonal LED.
SOUNDER FAULT		Illuminates should a Sounder Based Device indicates a fault condition.
SYSTEM FAULT		Illuminates should a fault become present with the control panel itself.
DETECTOR/ZONE DISABLED		Illuminates when a Detection Device or Zone is disabled.

Fig 3

6 Control Keyswitch:

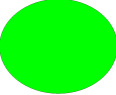
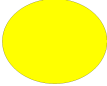
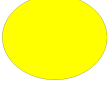
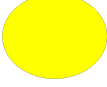
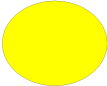
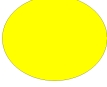

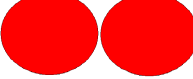
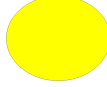
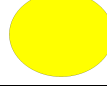



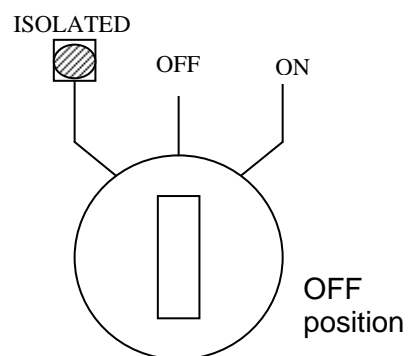

The Control Keyswitch has three different positions. They are “OFF”, “ON” and “ISOLATED”.

Each of their functions are explained on the following page: -

6.1 OFF (Normal) Position Functionality: (Access Level 1)

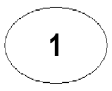
With the control keyswitch in the “OFF” position, the panel is at Access Level 1. The key is removable in this position and it is recommended that the panel is left in this position with the key removed. The following control options are available: -









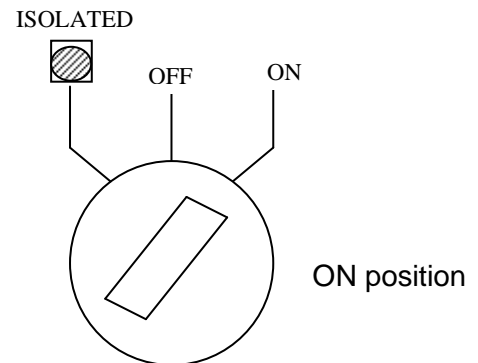

Scroll Buttons		Operational when multiple events are displayed to enable each event to be viewed.
Reset/Led Test		Operates Status lamp test when system has no events shown.
Silence Alarms		No operation.
Sound Alarms		No operation.
View Tests	 2 nd Feature of key	Displays any device/zone currently in test. This will automatically timeout and return to the Front Screen if left in this mode.
View Disablements	 2 nd Feature of key	Displays any device/zone currently disabled. This will automatically timeout and return to the front screen if left in this mode.
View Faults	 2 nd Feature of key	Displays any device currently in fault condition. This will automatically timeout and return to the front screen if left in this mode.
View Fires	 2 nd Feature of key	Returns to view fire events if any of the other view options used. This will automatically timeout and return to the front screen if left in this mode.
Status Lamps, (see fig 2)	N/A	Indicates the systems current status
System Menus	N/A	No Operation

6.2 ON Position Functionality: (Access Level 2)

The Control Panel requires the control keyswitch turned to the “ON” Position, enabling Access Level 2: -

The key may not be removed when in this position.



Scroll Buttons		Operational when multiple events are displayed to enable each event to be viewed.
Reset/Led Test		This button has two functions. It is firstly used to reset a Fire/Fault Event, after the “Silence Alarm” button has been pressed and the Fire/Fault condition has been cleared. It is secondly used to test all of the Systems Status Lamps. This is achieved by pressing the button when the Systems Status is normal, i.e. no events displayed.
Silence Alarms		This button Silences the System’s Sounders and internal buzzers. The panel will give an intermittent beep every 10 – 15 seconds until the condition is reset and will display Silence Alarms when pressed.
Sound Alarms		This key is used for activating the System’s Sounders. The display will show Alarms Sounded when pressed.
View Tests	 2 nd Feature of key	Displays any device/zone currently in test. This will automatically timeout and return to the front screen if left in this mode.
View Disablements	 2 nd Feature of key	Displays any device/zone currently disabled. This will automatically timeout and return to the front screen if left in this mode.
View Faults	 2 nd Feature of key	Displays any device currently in fault condition. This will automatically timeout and return to the front screen if left in this mode.
View Fires	 2 nd Feature of key	Returns to view fire events if any of the other view options used. This will automatically timeout and return to the front screen if left in this mode.
Status Lamps, (see fig 2)	N/A	Indicates the systems current status.
System Menus	N/A	Options and further Fire system Options Menus are now accessible by pressing the “0” Key. Details are shown in Section 7.

6.3 ISOLATED Position Functionality:

The Control Panel requires the control keyswitch turned to the ISOLATED position. Access Level 2 is accessible with the same features as detailed previously and all control buttons are operational. Plant Shutdown equipment can be disabled through this function as a pre selected Sounder Group can be disabled. This is normally used for isolating Plant Equipment whilst carrying out weekly tests. However, this is a programmable feature and can be configured by the installer/maintenance contractor if required.

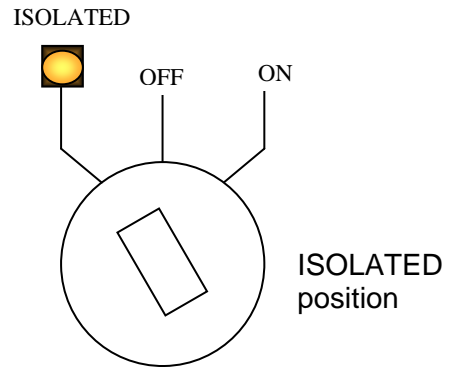

Scroll Buttons		Operational when multiple events are displayed to enable each event to be viewed.
Reset/Led Test		This button has two functions. It is firstly used to reset a Fire/Fault Event, after the “Silence Alarm” button has been pressed and the Fire/Fault Condition has been cleared. It is secondly used to test all of the Systems Status Lamps. This is achieved by pressing the button when the Systems Status is normal, i.e. no events displayed.
Silence Alarms		This button Silences the System’s Sounders and internal buzzers. The panel will give an intermittent beep every 10 – 15 seconds until the condition is reset and will display Silence Alarms when pressed.
Sound Alarms		This key is used for activating the System’s Sounders. The display will show Alarms Sounded when pressed.
View Tests	2 nd Feature of key	Displays any device/zone currently in test. This will automatically timeout and return to the front screen if left in this mode.
View Disablements	2 nd Feature of key	Displays any device/zone currently disabled. This will automatically timeout and return to the front screen if left in this mode.
View Faults	2 nd Feature of key	Displays any device currently in fault condition. This will automatically timeout and return to the front screen if left in this mode.
View Fires	2 nd Feature of key	Returns to view fire events if any of the other view options used. This will automatically timeout and return to the Front screen if left in this mode.
Status Lamps, (see fig 2)	N/A	Indicates the systems current status
System Menus	N/A	Options and further Fire system Options Menus are now accessible by pressing the “0” Key. Details are shown in Section 7.
Isolated Lamp	ISOLATED	Sounder group disabled by key position. This is a programmable feature normally used for isolating plant equipment on a weekly test and is configured by the Installer/Maintenance contractor.

7 User Option Functions:

The following Level 2 functions are available:

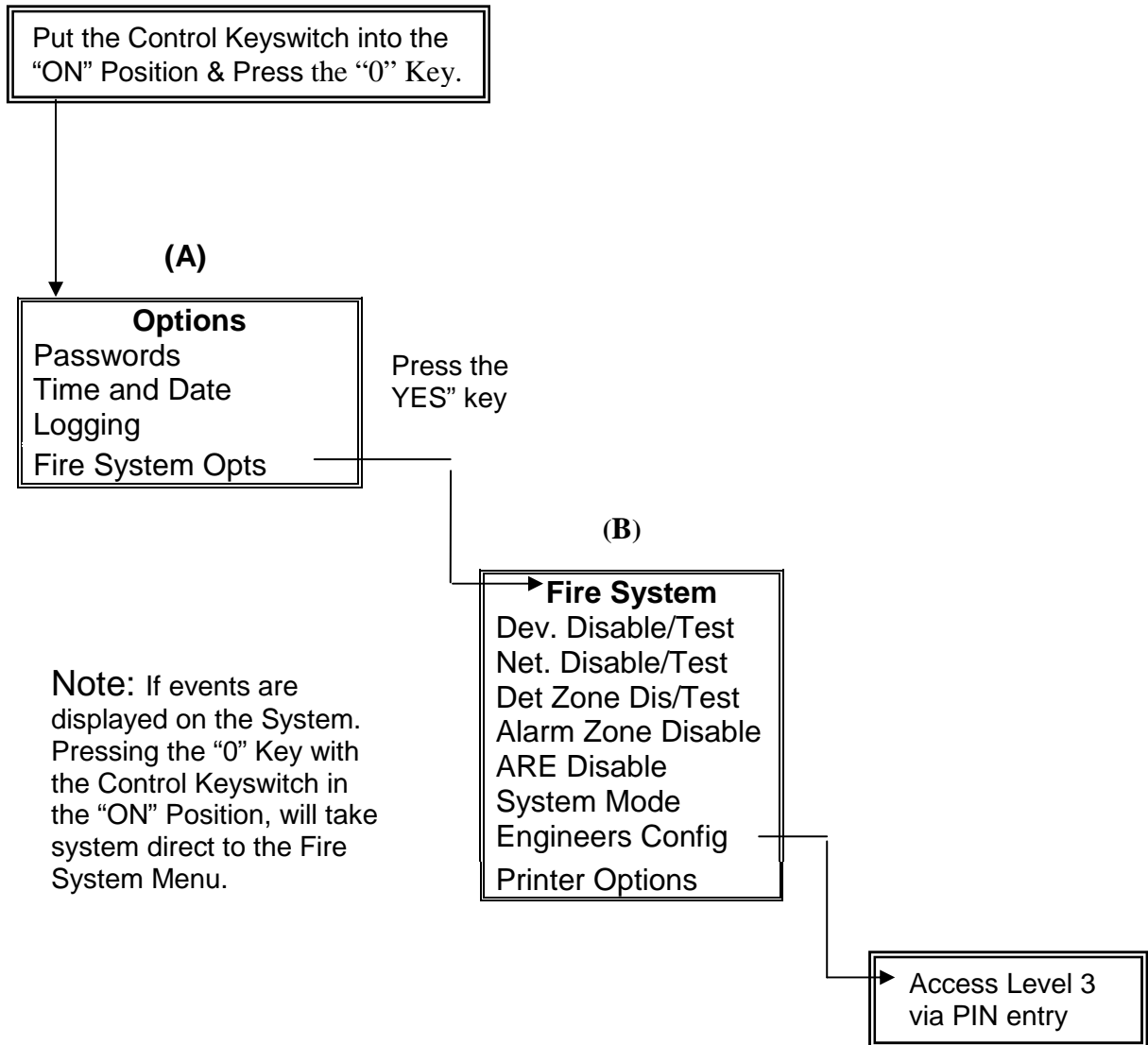

To scroll through the menus, use the "Δ" and "∇" scroll buttons. To enter a menu position the required option between the > and < cursors on the screen and press the "YES" key.

(A) Options:

FUNCTION	DESCRIPTION
Passwords	Contains 7 sub menus. This allows the option to change, edit and delete PIN numbers if used.
Time and Date	Gives the option to set and view the Time and Date.
Logging	Enables you to view the entire log of events, (up to 1000 events), or to view the log at a certain date.
Fire System Options	Allows access to (B) Fire System.

(B) Fire System:

FUNCTION	DESCRIPTION
Dev. Disable/Test	This option enables an individual device that forms part of the fire system to be Disabled, Activated or put into Test. The status lamps will illuminate/extinguish as appropriate.
Net. Disable/Test	This option enables the user to control individual devices that are logged onto other control panel's on the Networked Fire System. Such as a smoke detector or call point to be changed from their normal active status, to be disabled or put into test.
Det Zone Dis/Test	This option allows the Detection Zone to be viewed and altered. The zone can be either Active, Test or Disable. If any zones on the system are disabled or in test mode the relevant LED Indicators will light to indicate this.
Alarm Zone Disable	This option allows the disablement of groups of sounders within the system. The Alarm Zone can be either Enabled or Disabled. If Disabled the relevant LED indicator will illuminate.
ARE Disable	This option allows connection to the Fire Brigade via the Brigade Relay to be disabled. Therefore any subsequent fire activation's will not operate this relay. The panel operation, although unaffected, will display the text "ARE/BRIGADE DISABLED" to ensure the system is not left in this mode.
System Mode	This option allows enablement of up to eight different system modes of operation. These are pre-programmed and can be changed if required by the Installer/Maintenance Contractor.
Engineers Config	This option when entered prompts for a PIN number to be entered to Allow access to Level 3. This menu is for Installer/Maintenance Contractor use only.
Printer Options	This option allows the Printer, when fitted, to be both "Enabled" and "Disabled". When "Enabled" and the option is set to ALL, every Event is printed out. This option can also be set to FIRE, which will then only print Fire Events.

8 Alphanumeric Display Indicators: -

There are two different types of Displays. There is the Vacuum Fluorescent Display (VFD) type, which displays up to 80 characters, on a 4-line display. This is standard for 24 and 96 zone models.

A Liquid Crystal Display (LCD) type, is also available and is standard for 12 and 4 zone models.

There are different types of conditions that are shown on the display, to suit different circumstances. Below are some display indication screen shots: -

8.1 Non-Alarm Conditions:

Under Non-Alarm Conditions, the display should show: -

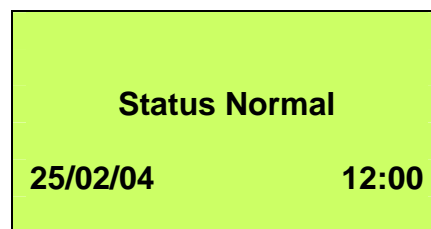

The Green "Power" LED should also be illuminated.

8.15 Fire Event:

When a Fire event occurs the text on the display changes, to show: -

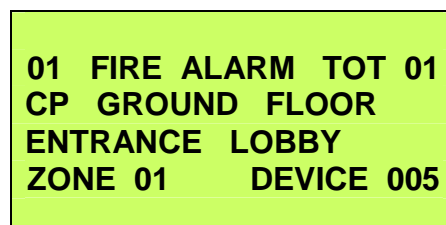

The above shows that Device 5 has generated a Fire event in Zone 1.

8.2 Fire (Networked Device):

When a device on a Networked Control Panel has activated a Fire Alarm, the following alarm screen will be shown: -

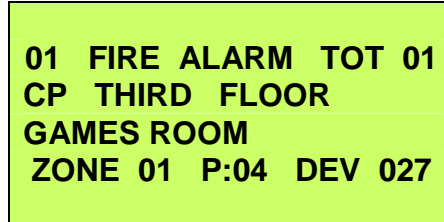

```
01 FIRE ALARM TOT 01
CP THIRD FLOOR
GAMES ROOM
ZONE 01 P:04 DEV 027
```

The above display shows that a Fire Alarm has been generated from Device 27, in Zone 1 on Panel 4.

8.25 Pre-Alarm:

When a Pre-Alarm event occurs the text on the display changes to show: -



```
01 PRE-ALARM TOT 01
SS FIRST FLOOR
MAIN BEDROOM
ZONE 03 DEVICE 027
```

The above display shows that Device 27 has entered a Pre-Alarm event, in Zone 3.

8.3 Tamper:

When a device generates a Tamper Alarm, the display will change to show: -

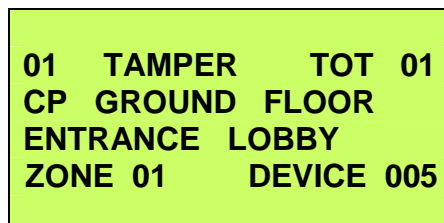

```
01 TAMPER TOT 01
CP GROUND FLOOR
ENTRANCE LOBBY
ZONE 01 DEVICE 005
```

The above shows that Device 5 has generated a Tamper Alarm in Zone 1.

8.35 Fault Event:

When a Fault Event occurs the text on the display changes to show: -

01 FAULT	TOT 01
RS SECOND FLOOR	
MAIN CORRIDOR	
ZONE 04	DEVICE 056

The above display, tells us that device 56, has entered a Fault condition in Zone 4.

8.4 Fault : MN:

In the instance of a system mains failure, the controller will switch into battery safe mode. This will turn the display completely off, and the “Power” LED will extinguish. Pressing any key on the panel will re-activate the display and the following fault screen will be shown: -

01 FAULT	TOT 01
CONTROL PANEL	
FAULT : MN	12:00

FAULT MN represents the controller has had a mains failure.
The “CIE Fault” LED will also illuminate when the above screen is displayed.

8.45 Fault : BT:

This fault can be displayed for a number of reasons. There maybe no batteries present in the unit. Secondly the batteries may not be charging. Thirdly the battery voltage may be low. The battery not charging and low voltage readings would be displayed after the daily check at midday. The fault would be displayed immediately when batteries are not present. For any of these instances the following screen would be displayed: -

01 FAULT	TOT 01
CONTROL PANEL	
FAULT :BT	12:00

8.5 Fault : PR:

Whenever the control panel's internal processor is reset, (including initial power up), the following fault screen will be shown: -

01 FAULT	TOT 01
CONTROL PANEL	
FAULT :PR	12:00

8.55 Fault : RI:

Radio signal levels can vary due to the surrounding local environment. The following screen shows that the controller is receiving unknown radio signals above an acceptable level: -

01 FAULT	TOT 01
CONTROL PANEL	
FAULT : RI	12:00

The Fault RI represents that the panel is receiving Radio Interference.

8.6 Fault : OL:

This fault shows that a controller is currently Off Line on either a Hardwired or radio networked system. This indicates the Control Panel is no longer communicating with the Network System. If this has taken place the following fault screen will be shown:-

01 FAULT	TOT 01
CONTROL PANEL	
FAULT :OL	12:00

9 Step by Step Guidance:







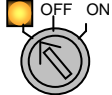

9.1 Weekly Test Recommendations.

A manual callpoint should be tested on the system each week. It is recommended that the test be carried out at the same time each week with any poor audibility instances reported.

A different manual callpoint should be tested each week to ensure that all callpoints are tested over time.

The results of the test and the callpoints used should be recorded in the logbook. If the system is connected to an alarm receiving centre they should be informed before and after the test and the fire alarm signal confirmed.

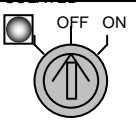
Carrying Out the Test.

If applicable contact the alarm receiving centre to inform them that a test is about to be carried out.	 ISOLATED
Turn the key on the control panel to the ISOLATED position.	
Wait 15 seconds.	 15 seconds
Activate a manual callpoint by inserting the test key.	
Fire alarm with text and zonal indication will now be displayed on the control panel along with sounder operation.	
Wait for 30 seconds.	 30 seconds
Press the silence alarms button. (The time period shown is an average time and maybe reduced if required, dependant on the size of the system).	 SILENCE ALARMS
Press the Reset alarms button to reset the fire alarm event.	 RESET/ LED TEST
The display should return to normal. The key should be returned to the OFF position and removed from the control panel.	
If applicable contact the alarm receiving centre and confirm that the test has been completed and verify signal received.	
The test is now complete and the logbook should now be updated.	

9.2 Setting the Time and Date: -

To change the time and date, turn the control keyswitch into the “ON” position. Now press the “0” Key. Press the “∇” button once until “> Time and Date <”. Is displayed.

Press the “YES” key and you will enter the “| ** Date/Time **|” Menu.

To set the time, press the “YES” key again, and enter the time in 24hr, hh:mm format. Then press the “YES” key to confirm. Press the “NO” key twice to return to the main display.

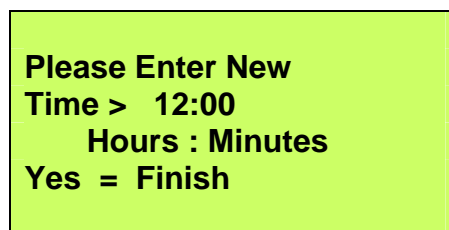

**Please Enter New
Time > 12:00
Hours : Minutes
Yes = Finish**

To enter the date, (from the Date/Time Menu), press the “∇” button twice until highlighting “>Set the Date <” then press the “YES” key. Now enter the date in dd:mm:yy format and then press the “YES” key to confirm. Once confirmed, press the “NO” key twice to return to the main display.

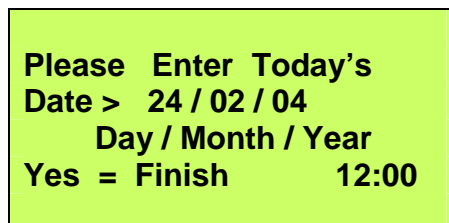

**Please Enter Today's
Date > 24 / 02 / 04
Day / Month / Year
Yes = Finish 12:00**

NOTE: On Multi-panel systems, it is only necessary to alter the time and date on the Master Panel and this will automatically pass the information to other panel's on the system.

9.3 Enabling/Disabling Devices:

To Enable/Disable a device from the main screen:

With the control keyswitch in the “ON” Position, press the “0” key, then scroll down to last option, “Fire System Options”.

Press the “YES” key. Now, whilst highlighting the “>Dev. Disable/Test<” option, press the “YES” key again.

Now press the “0” key and enter the desired device number and press the “YES” key. The display will show: -

```
| **   Device Status *   |
> Number is : 006 <
| Status is : Active |
Yes = Select      12:00
```

```
| Number is : 006 |
> Status is :Disable <
| Det . zone : 02 |
Yes = Select      12:00
```

Note: If an event is displayed the Fire System Menu is immediately accessed by turning the Key into the “ON” Position and pressing the “0” Key.

Then press the “∇” button to highlight “>Status is :Active <”, and scroll through the different status types by pressing the “YES” key until desired option has been found, then press the “NO” key three times, to return to the main display.

Whilst a device is disabled, the “DETECTOR/ZONE DISABLED” LED Indicator will illuminate. When the devices are enabled the LED Indicator will extinguish, unless any detection zones are disabled.

9.5 Enabling/Disabling Brigade Relay:

To Enable or Disable the Brigade Relay turn the control keyswitch to the “ON” Position and Press the “0” key. Scroll down to the bottom of the Options Menu using the “∇” button, until highlighting “>Fire System Options<”. Press the “YES” key. Press the “∇” button until highlighting the “>ARE Disable <” option. Press the “YES” key. Then press the “YES” key again to change from “ENABLED” TO “DISABLED” alternately.

ARE / Brigade ENABLED
Push YES to change
Push NO to escape
Push YES / NO

ARE / Brigade DISABLED
Push YES to change
Push NO to escape
Push YES / NO

Then having selected the desired option, press the “NO” key three times to return to the main display.

9.6 Printer Options: -

To enter the Printer options from the main display, put the control keyswitch into the “ON” position. Press the “0” key. Now using the “∇” button, scroll down to the last option, “>Fire System Options<”. Now press the “YES” key. Then scroll down, pressing the “∇” button to the last option, “>Print Options <”. Now, press the “YES” key.

Now having reached the “Print Options”, press the “YES” key to turn the Printer “ON” or “OFF”. Whilst the printer is set to “ON”, press the “∇” button, then press the “YES” key to change the print event between “FIRE” or “ALL”.

| * Print Options * |
 > Printer is ON <
 | Print Events ALL |
 Yes = Select 12:00

| * Print Options * |
 | Printer is ON |
 > Print Events FIRE <
 Yes = Select 12:00

This depends on whether the printer is required to print All events or just any Fire Events. Once suitably configured, press the “NO” key three times to return to the main display.

9.7 Viewing the Event Log:

Turn the control keyswitch to the "ON" position and press "0" key. The screen will now display:

```

| *** Options **** |
| > Passwords      < |
| Time and Date   |
| Yes = Select    Time |

```

Press the ∇ key twice until the screen displays ">Logging< ". Press the "YES" key and the screen will change to highlight ">View Log At Date< ". Now press the "YES" key and the screen will now display:

```

Enter the date to
View:      /  /

Yes = Finish    Time

```

Enter the required date to view in dd/mm/yy Format, (e.g.28/05/03) then press the Yes key and the screen will now display:

```

-----
On 28/05/03 At 00:00
New Day of 28/05/03
Yes = Select    Time

```

By pressing the, Δ and ∇ scroll buttons, the log for the date selected can be viewed. All fire and fault events are listed in date and time order. Pressing the "5" key will take you to the oldest event, whilst pressing the "8" key will take you to the most recent event.

When finished, press the "NO" key three times until the screen returns to the main display. Turn the control keyswitch to the off Position and the screen will now indicate that the Status is Normal.

9.8 Enabling/Disabling Networked Devices:

Turn the control keyswitch to the “ON” position. Press “0” key to enter the “Options” Menu. Press the ∇ key three times until the screen displays:” >Fire System Opts<”. Press the “YES” key and the screen will change to highlight “>Dev.Disable/Test<”. Press ∇ key once to highlight the option “> Net. Disable /Test<” and press the “YES” key and the screen will now display:

```

| * Network Status * |
> Panel Type : PAN <
| Panel : 00 |
Yes = Select Time

```

NOTE: It is important the correct Panel type is highlighted.
 PAN = Hardwired Panels. NET = Radio Network Panels.
 This information can be provided by installer/Maintenance Contractor if required.

Press “YES” key once to change the Panel type to the required setting.
 Press the ∇ key one time and the screen will now be highlighting, ”>Panel : 00<”.
 Press the “YES” key to change the panel number until the desired panel number is shown: Press ∇ key one time and the screen will change to highlight, ”>Device : 00<”. Press “0” key and the screen will now display:

```

Enter Device
(Number 1 - 256)
Number > _
Yes = Finish Time

```

Enter the device number that you want to Enable/Disable e.g. 007, then press “YES” key and screen will now display:

```

| Panel : 04 |
>Device : 007 <
| Status : Active |
Yes = Select Time

```

Press the ∇ key one time and the screen will change to highlight “>Status : Active<”. Press “YES” key once to change the Status of the device to Active or Disabled as desired. Now press the ∇ key once and whilst highlighting “>Transmit Event<”, press the “YES” key to transmit the event. The screen will state that the change has been made.

Press “NO” key four times until the screen returns to the main display. Turn the control keyswitch to the “OFF” Position and the screen will now indicate that the Status is Normal.

9.9 Selecting Verify Delay Operation:

Delay Mode Operation

The panel can be configured to operate in a delayed mode either manually or via a secondary keyswitch.

When selected, alarm signals received from a detector will generate a fire alarm message on the panel but delay the operation of the sounders. The panel will initiate a full fire alarm condition if no action is taken on this warning within a specified period.

The use of visual delay mode must be configured at level 3, by an installer/maintenance contractor, before it is available for use at level 2.

The visual delay mode can be configured to operate when manually selected at the panel, via a secondary keyswitch or automatically via a separate timer. The maximum time allowed for acknowledging the timer can be programmed in intervals of one second.

Whilst the visual delay mode Function is active the front screen will display VERIFY DELAY MODE.

Standard Delay Operation

When a fire alarm condition is detected in this mode, the internal buzzer will sound. The device location will be shown on the display along with a warning that the panel has entered delayed alarm.

If the warning is not acknowledged, by pressing the "SILENCE ALARM" button, within the time allowed, then a full fire alarm condition will be raised and the sounders will activate.

Pressing the "SILENCE ALARM" button within the time allowed will cause the timer to stop.

A secondary device activating within the timer or a manual callpoint activation will immediately generate a fire alarm condition.

10 Routine Tests: -

In order to ensure that the system is fully operational and to ensure compliance with B.S.5839 Part1: 2002, the following routine tests to the system should be carried out.

Note: Records should be maintained of all testing activities, on the enclosed Logbook Data Table.

10.1 Daily:

Check the control panel to ensure that it indicates normal operation. (Status should be Normal). If any fault is indicated, check that it has been recorded in the logbook event data table and that the appropriate actions have been taken. E.g. informing the maintenance company.

10.2 Weekly:

Test at least one detector or call point, to confirm the operation of the panel and the audible alarms. A different zone should be tested each week and, if possible, a different device. Record the outcomes of the testing.

The zone and the device number should be noted into the Control Panel logbook. Any malfunctions must be reported. The "LED TEST" key should be pressed to ensure that all of the LED Indicators are in full working order.

10.3 Quarterly:

The person nominated with the responsibility for the system, should ensure that a competent person checks the system every 3 months. The competent person shall: -

- i) Check the Logbook Event Data Table entries, and the results of any action taken.
- ii) Check the standby batteries and the charger voltage.
- iii) Test at least one device in each zone, to verify the functionality of the Control Panel.
- iv) Check the operation of the audible alarms and any link to a remote manned centre, central station, etc.
- v) Carryout a visual inspection of the system to check for alterations or obstructions.
- vi) Issue a Certificate of Testing.

10.4 Annually:

The responsible person should ensure that, in addition to the quarterly checks, each device on the system is tested and that a visual inspection is made of the cable fittings and equipment.

10.5 Periodic Cleaning:

The Control Panel and devices should be periodically cleaned, by wiping with a soft damp cloth.

However, the use of solvents on the Control Panel or Devices is not recommended.

11 Logbook: -

One or more individuals should be appointed, to maintain a Logbook and to oversee all entries and record all events resulting from or affecting the system.

The Logbook should be kept in a safe place, closely situated to the Control Panel. It should only be accessible to those authorised persons

The names of the responsible appointed persons should be recorded on the Reference Data Table below.

All events including real and false Fire Events, Faults, Pre-Alarm Warnings, Tests, temporary Disablements should be properly recorded.

Service visits should also be recorded. Such recordings should be accompanied with brief notes of any work that has been or is to be carried out.

Such Reference Data should be detailed in the sample below: -

Site Name and Address:	

Site Telephone No:	
Responsible Person(s): -	Date:
	Date:
	Date:
System Installer:	
This System is Maintained by:	Until:
Maintenance Companies Contact Telephone No:	

Reference Data Table:

On the next page, is a sample page of the Logbook. This can be photocopied to produce a suitable Logbook:

Date	Time	Event/Dev No/Zone No	Action Taken	Date Completed	Initials



EMS Group Head Office
Technology House
Sea Street
Herne Bay
Kent CT6 8JZ
England

Tel: +44 (0) 8712 710804
Fax: +44 (0) 1227 369679
Email: enquiries@emsgroup.co.uk

www.emsgroup.co.uk

Dealer Information

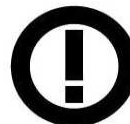

This product is intended for use within the United Kingdom under the provisions of Directive 199/5/EC.



Calls are charged at up to 10p (incl. VAT) per minute, on the BT Network. Mobile and other Network costs may vary.

The information contained within this literature is correct at time of publishing. The EMS Group reserves the right to change any information regarding products as part of its continual development enhancing new technology and reliability. The EMS Group advises that any product literature issue numbers are checked with its head office prior to any formal specifications being written.